

ASSEMBLY INSTRUCTION

Model# 2911BK

ATTENTION:





FIXTURE INSTALLATION MUST BE DONE BY LICENSED ELECTRICIAN.

SHUT OFF POWER SUPPLY AT FUSE OR CIRCUIT BREAKER.

USE ONLY THE SPECIFIED BULBS AND DO NOT EXCEED THE MAXIMUM WATTAGE.

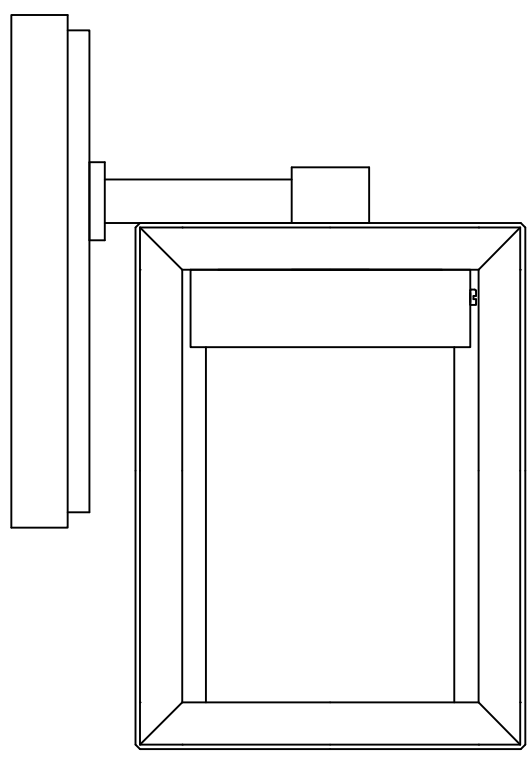
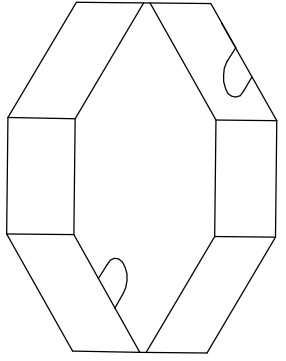
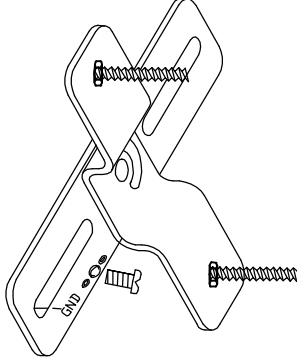
BEFORE YOU INSTALL:

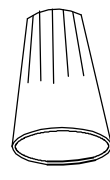
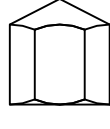
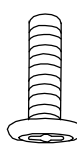
1. Check the fixture frame for any physical damage
2. Check all parts and crystals to ensure they are not damaged or missing
3. Test all sockets with a bulb for conductivity before "dressing" the fixture
4. If there is any problem, please do not install the fixture, please contact the vendor and solve the problem first.

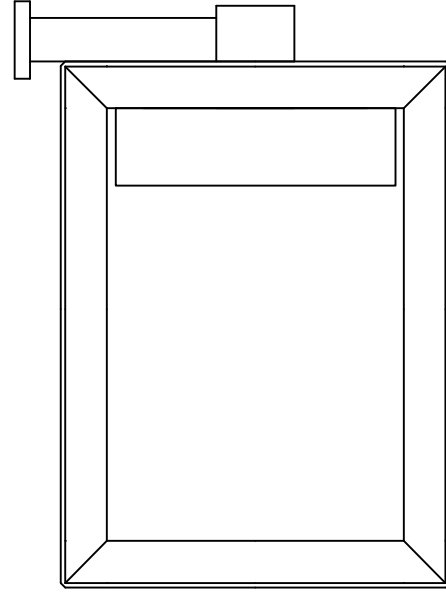
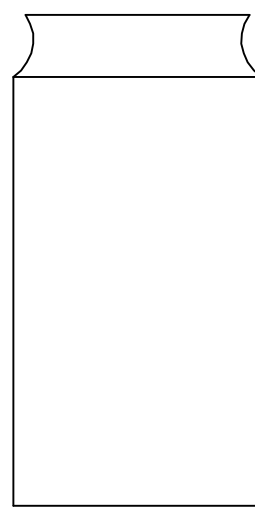
	 not included no incluido non inclus X1	 X1	 X2	 X3	 X2
	 X3	 X1	 X1	 X1	

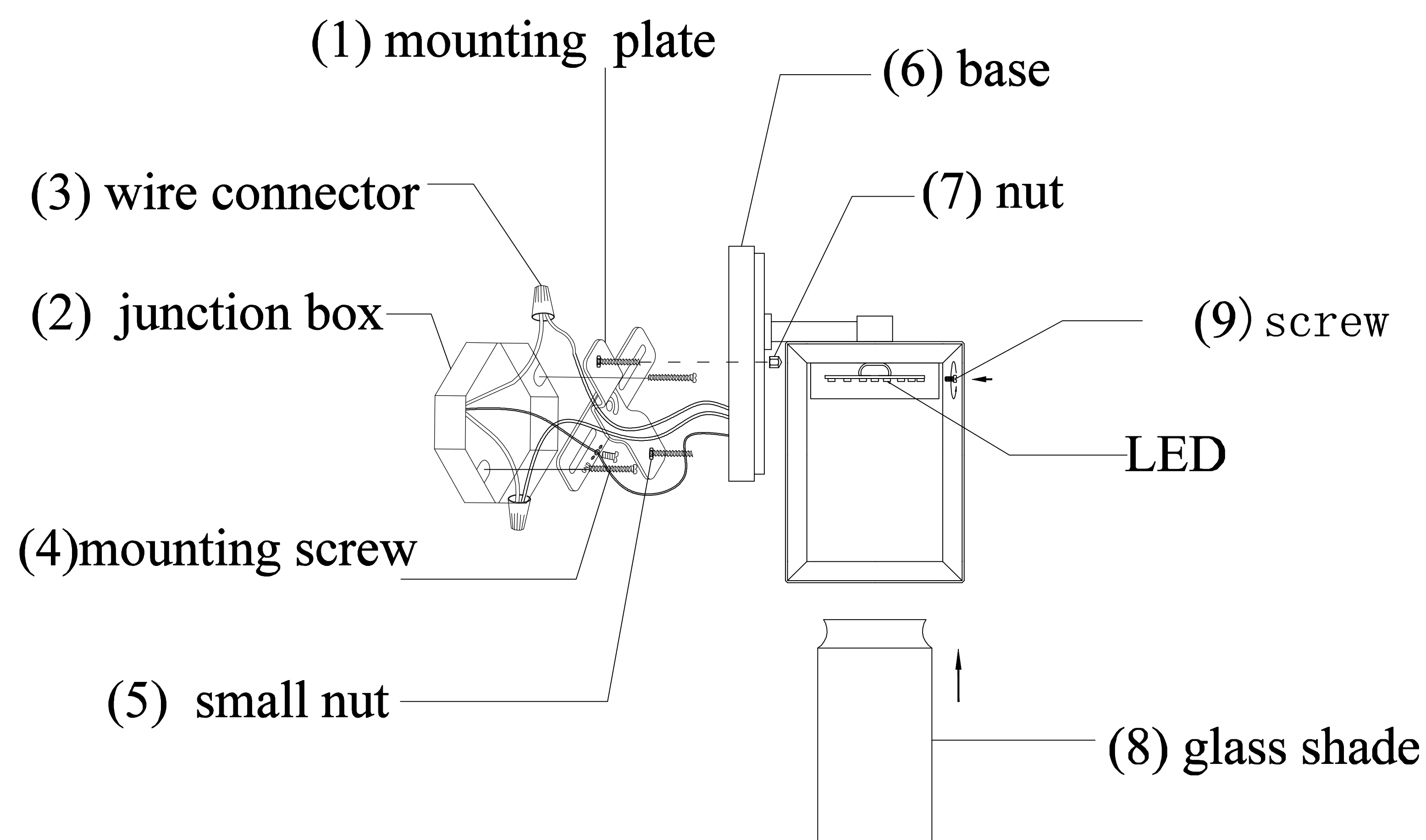

Please turn off power to the outlet and review instructions before installation. The installation must be handled by a qualified licensed electrician. Also, be sure to turn off power before changing the bulb or cleaning the fixture.

1. Insert the mounting plate(1) to the wall by using the mounting screw(4)to the junction box (2)(not included)
2. Connect the wire by using the wire connector(3). (Note: Connect the black wire to the black(Hot) , the white wire to the white(Neutral), and the ground wire to the ground post.).
3. Adjust the mounting screws(4) on the board with small nut(5)
4. Install the base(6) by using the nut (7).
5. Insert the glass shade(8)by using the screw(9).
6. Turn on the lights and complete the assembly.